



Multi Language Quick Guide

8-Channel Hybrid DVR

C8XVR



V1.0

Conceptronic C8XVR

1. Package contents

The following items are present in the package of the Conceptronic DVR:

- DVR x 1
- SATA Data Cable x 1
- SATA Power Cable x 1
- Power Adaptor x 1
- USB Mouse x 1
- Resource CD x 1
- QIG x 1

2. Installation & usage

Step 1. Install the HDD.

1) Loosen the screws and remove the cover.



2) Connect the data cable and power cable to the HDD.

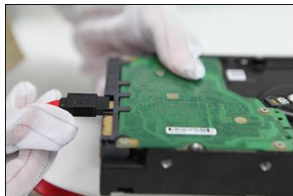
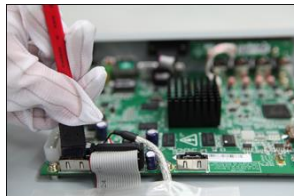

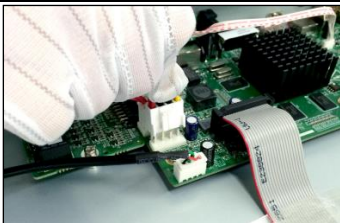

3) Place the HDD on the bottom of the device and fix it.

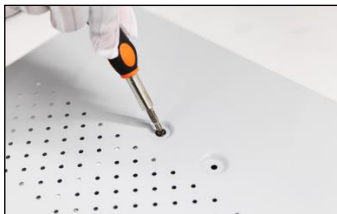

4) Re-install the cover of the DVR and fasten screws.

Note: The HDD installation steps vary according to different models.

Step 2. Connect peripheral devices to the DVR.

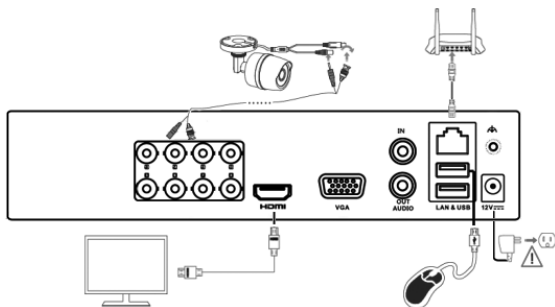

Step 3. Power on the DVR.

Step 4. Activate the DVR for initial access. Input a strong password and confirm it.

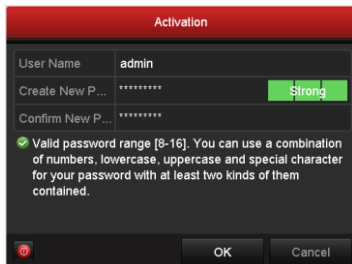

The Activation screen displays the following information:

User Name	admin
Create New P...	***** Strong
Confirm New P...	*****

Valid password range [8-16]. You can use a combination of numbers, lowercase, uppercase and special character for your password with at least two kinds of them contained.

Buttons: OK, Cancel

Step 5. Log in to the DVR. Input the admin password.

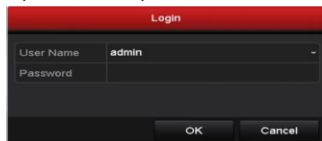

The Login screen displays the following information:

User Name	admin
Password	

Buttons: OK, Cancel

Step 6. Follow the Setup Wizard to configure the network cameras.

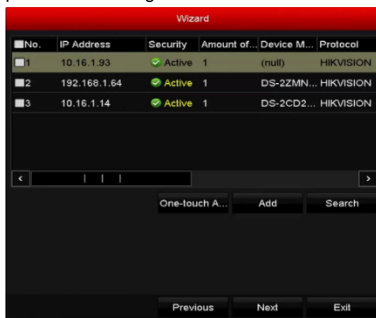

The Wizard screen displays a table of network cameras:

No.	IP Address	Security	Amount of...	Device M...	Protocol
1	10.16.1.93	Active	1	(null)	HIKVISION
2	192.168.1.64	Active	1	DS-2ZMN...	HIKVISION
3	10.16.1.14	Active	1	DS-2CD2...	HIKVISION

Buttons: One-touch A..., Add, Search, Previous, Next, Exit

Step 7. You can perform the operation and configuration of the device, including the live view, record schedule, playback, backup, etc..



(Optional) You can also log in to the DVR to configure and operate via web browser. Input the IP address of the device and then press Enter.



Enjoy the use of your Conceptronic DVR!

1. Packungsinhalt

Folgende Teile befinden sich in der Verpackung von Conceptronic DVR:

- DVR x 1
- SATA Data Cable x 1
- SATA Power Cable x 1
- Power Adaptor x 1
- USB Mouse x 1
- Resource CD x 1
- QIG x 1

2. Installation & Verwendung

Step 1. HDD installieren

- 1) Lösen Sie die Schrauben und entfernen Sie die Abdeckung.



- 2) Schließen Sie das Daten- und das Stromversorgungskabel an der HDD an.

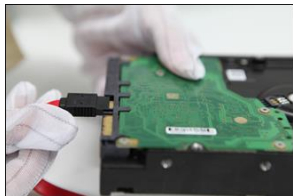
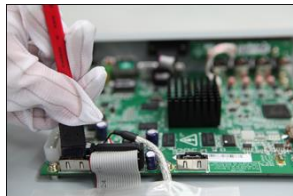

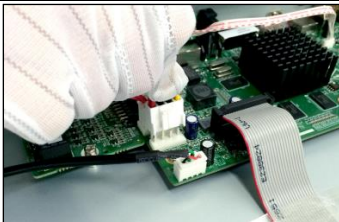

- 3) Befestigen Sie die HDD am Geräteboden.



- 4) Bringen Sie die Abdeckung wieder am DVR an und ziehen Sie die Schrauben fest.

Hinweis: Die Schritte bei der HDD-Installation variieren je nach Modell.

Step 2. Schließen Sie die Peripheriegeräte am DVR an.

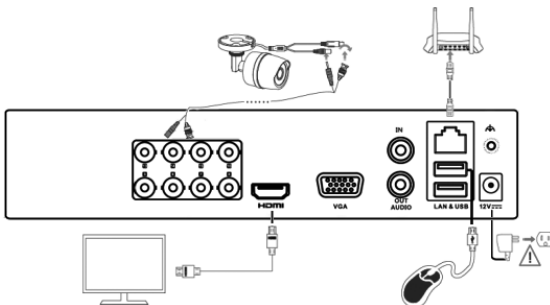

Step 3. Schalten Sie den DVR ein.

Step 4. Aktivieren Sie den DVR für den erstmaligen Zugriff. Geben Sie ein starkes Kennwort ein und bestätigen Sie es.

Activation

User Name	admin
Create New P...	***** Strong
Confirm New P...	*****

Valid password range [8-16]. You can use a combination of numbers, lowercase, uppercase and special character for your password with at least two kinds of them contained.

OK Cancel

Step 5. Melden Sie sich beim DVR an. Geben Sie das Administratorkennwort ein.

Login

User Name	admin
Password	

OK Cancel

Step 6. Befolgen Sie die Anweisungen des Konfigurationsassistenten, um das Netzwerk-Kameras.

Wizard

No.	IP Address	Security	Amount of...	Device M...	Protocol
1	10.16.1.93	Active	1	(null)	HIKVISION
2	192.168.1.64	Active	1	DS-2ZMN...	HIKVISION
3	10.16.1.14	Active	1	DS-2CD2...	HIKVISION

One-touch A... Add Search

Previous Next Exit

Step 7. Sie können Betriebs- und Gerätefunktionen wie Liveansicht, Aufnahmezeitplan, Wiedergabe, Backup usw. konfigurieren.



(Optional) Sie können sich über einen Webbrowser beim DVR anmelden, um ihn zu konfigurieren und zu bedienen. Dazu geben Sie die IP-Adresse des Geräts ein und drücken Sie die Eingabetaste.



Viel Spaß mit Ihrem Conceptronic DVR!

1. Contenu du Coffret

Les éléments suivants se trouvent dans l'emballage de votre Conceptronic DVR:

- DVR x 1
- SATA Data Cable x 1
- SATA Power Cable x 1
- Power Adaptor x 1
- USB Mouse x 1
- Resource CD x 1
- QIG x 1

2. Installation & Utilisation

Step 1. Installez le disque dur.

- 1) Desserrez les vis et retirez le capot.



- 2) Raccordez le câble des données et le câble d'alimentation au disque dur.

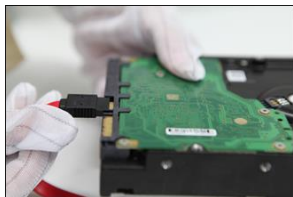
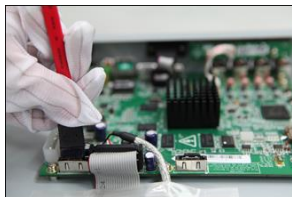

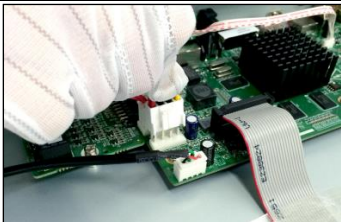

3) Positionnez le disque dur au bas de l'appareil et fixez-le.



4) Réinstallez le capot du DVR et serrez les vis.

Remarque : Les étapes de l'installation du disque dur varient selon les modèles d'appareil.

Step 2. Raccordez les éventuels périphériques au DVR.

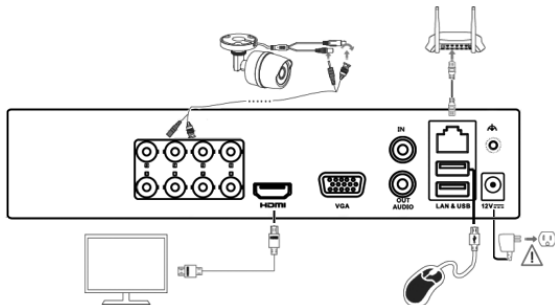

Step 3. Mettez le DVR sous tension.

Step 4. Activez le DVR pour un premier accès à celui-ci. Saisissez un mot de passe robuste et confirmez-le.

Step 5. Connectez-vous au DVR. Saisissez le mot de passe administrateur.

Step 6. Suivez l'assistant d'installation notamment pour configurer le réseau caméras.

No.	IP Address	Security	Amount of...	Device M...	Protocol
1	10.16.1.93	Active	1	(null)	HIKVISION
2	192.168.1.64	Active	1	DS-2ZMN...	HIKVISION
3	10.16.1.14	Active	1	DS-2CD2...	HIKVISION

Step 7. Vous pouvez procéder à la configuration et à l'exploitation de l'appareil, notamment effectuer un affichage en direct, planifier et lire un enregistrement, ou encore effectuer une sauvegarde.



(Facultatif) Vous pouvez également utiliser un navigateur Web pour vous connecter au DVR, et le configurer et l'exploiter. Saisissez l'adresse IP de l'appareil puis appuyez sur Entrée.



Profitez de votre Conceptronic DVR!

Conceptronic C8XVR

1. Contenido del paquete

El paquete contiene los siguientes artículos de Conceptronic DVR:

- DVR x 1
- SATA Data Cable x 1
- SATA Power Cable x 1
- Power Adaptor x 1
- USB Mouse x 1
- Resource CD x 1
- QIG x 1

2. Instalación & Utilización

Step 1. Instalar la unidad HDD.

1) Afloje los tornillos y retire la cubierta.



2) Conecte el cable de datos y el cable de alimentación a la HDD.

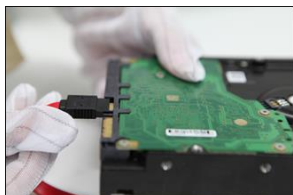
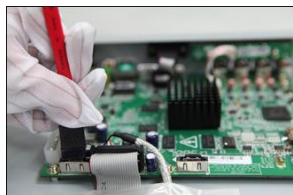

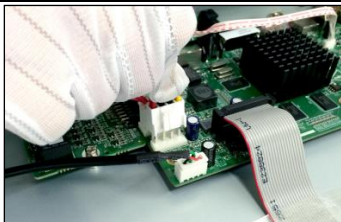

3) Coloque la HDD en la parte inferior del dispositivo y fíjela.



4) Volver a colocar la cubierta del DVR y apretar los tornillos.

Nota: Los pasos de la instalación de la HDD varían en función de los diferentes modelos.

Step 2. Conectar los dispositivos periféricos al DVR.

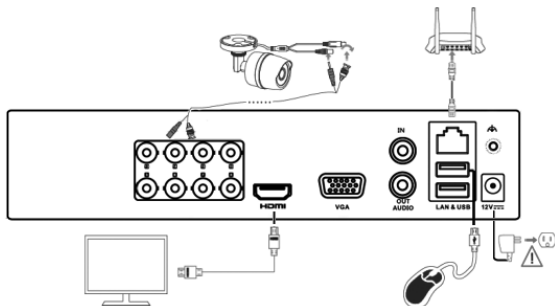

Step 3. Encender el DVR.

Step 4. Activar el DVR para realizar un acceso inicial. Introducir una contraseña segura y confirmar.

The screenshot shows the 'Activation' screen. It has a red header with the word 'Activation'. Below the header, there are three input fields: 'User Name' with the value 'admin', 'Create New P...' with a masked password '*****', and 'Confirm New P...' also with a masked password '*****'. To the right of the password fields is a green button labeled 'Strong'. Below the input fields, there is a green checkmark icon followed by the text: 'Valid password range [8-16]. You can use a combination of numbers, lowercase, uppercase and special character for your password with at least two kinds of them contained.' At the bottom of the screen, there are two buttons: 'OK' and 'Cancel'.

Step 5. Iniciar sesión en el DVR. Introducir la contraseña de administrador.

The screenshot shows the 'Login' screen. It has a red header with the word 'Login'. Below the header, there are two input fields: 'User Name' with the value 'admin' and 'Password' which is empty. At the bottom of the screen, there are two buttons: 'OK' and 'Cancel'.

Step 6. Seguir el asistente de instalación para configurar la red cámaras.

The screenshot shows the 'Wizard' screen. It has a red header with the word 'Wizard'. Below the header, there is a table with the following data:

No.	IP Address	Security	Amount of...	Device M...	Protocol
1	10.16.1.93	Active	1	(null)	HIKVISION
2	192.168.1.64	Active	1	DS-2ZMN...	HIKVISION
3	10.16.1.14	Active	1	DS-2CD2...	HIKVISION

Below the table, there are navigation arrows and a search bar. At the bottom of the screen, there are three buttons: 'Previous', 'Next', and 'Exit'.

Step 7. Puede realizar el funcionamiento y la configuración del dispositivo, incluyendo live view, programación de grabaciones, reproducción, copia de seguridad, etc.



(Opcional) También puede iniciar sesión en el DVR para configurarlo y operarlo a través del navegador web. Introduzca la dirección IP del dispositivo y, a continuación, pulse Intro.



¡Disfrute del uso de su Conceptronic DVR!

Conceptronic C8XVR

1. Pakkens indhold

La confezione di Conceptronic DVR contiene gli elementi che seguono:

- DVR x 1
- SATA Data Cable x 1
- SATA Power Cable x 1
- Power Adaptor x 1
- USB Mouse x 1
- Resource CD x 1
- QIG x 1

2. Installazione & Uso

Step 1. Installare l'HDD.

- 1) Allentare le viti e rimuovere il coperchio.



- 2) Collegare il cavo dati e il cavo di alimentazione all'HDD.

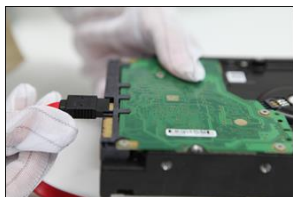
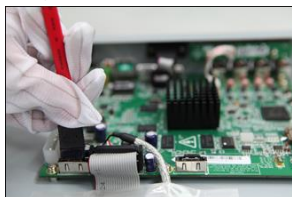

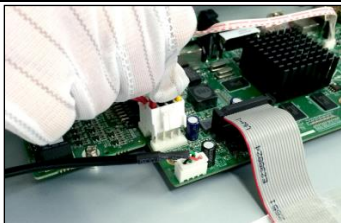

3) Posizionare l'HDD sul fondo del dispositivo e fissarlo.

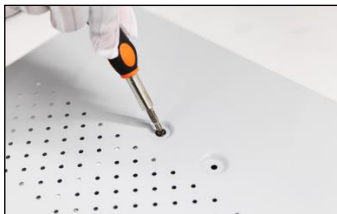

4) Re-installare il coperchio del DVR e serrare le viti.

Nota: La procedura di installazione dell'HDD varia a seconda dei diversi modelli.

Step 2. Collegare le periferiche al DVR.

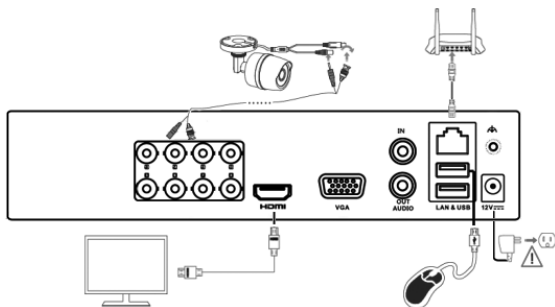

Step 3. Accendere il DVR.

Step 4. Attivare il DVR per l'accesso iniziale. Inserire una password sicura e confermarla.

Activation

User Name	admin
Create New P...	***** Strong
Confirm New P...	*****

✔ Valid password range [8-16]. You can use a combination of numbers, lowercase, uppercase and special character for your password with at least two kinds of them contained.

OK Cancel

Step 5. Accedere (login) al DVR. Inserire la password dell'amministratore.

Login

User Name	admin
Password	

OK Cancel

Step 6. Seguire l'installazione guidata per configurare la rete videocamera.

Wizard

No.	IP Address	Security	Amount of...	Device M...	Protocol
1	10.16.1.93	Active	1	(null)	HIKVISION
2	192.168.1.64	Active	1	DS-2ZMN...	HIKVISION
3	10.16.1.14	Active	1	DS-2CD2...	HIKVISION

One-touch A... Add Search

Previous Next Exit

Step 7. È possibile operare e configurare il dispositivo, inclusi vista live, programmazione registrazioni, playback, backup, ecc.



(Opzionale) È possibile anche accedere al DVR per configurarlo e gestirlo tramite browser web. Inserire l'indirizzo IP del dispositivo e premere Invio.



Godetevi l'uso di Conceptronic DVR!

1. Conteúdo da embalagem

A embalagem do Conceptronic DVR contém os seguintes itens:

- DVR x 1
- SATA Data Cable x 1
- SATA Power Cable x 1
- Power Adaptor x 1
- USB Mouse x 1
- Resource CD x 1
- QIG x 1

2. Instalação & Utilização

Passo 1. Instalar o HDD.

- 1) Desaperte os parafusos e remova a tampa.



- 2) Ligue o cabo de dados e o cabo de alimentação ao HDD.

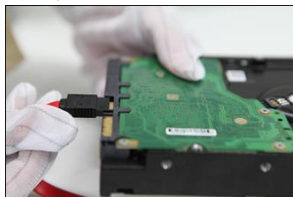
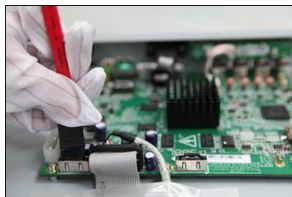

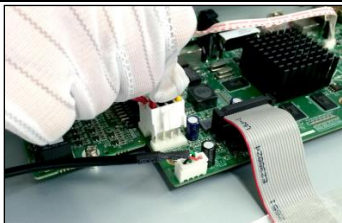

- 3) Coloque o HDD na parte inferior do dispositivo e fixe-o.

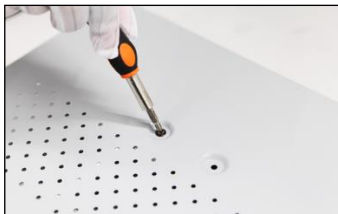

- 4) Volte a colocar a tampa do DVR e aperte os parafusos.

Nota: Os passos de instalação do HDD podem variar de acordo com os diferentes modelos.

Passo 2. Ligue dispositivos periféricos ao DVR.

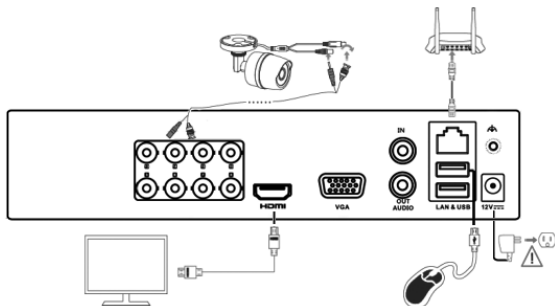

PORTUGUÊS

Passo 3. Ligue o DVR.

Passo 4. Ative o DVR para acesso inicial. Introduza uma palavra-passe forte e confirme-a.

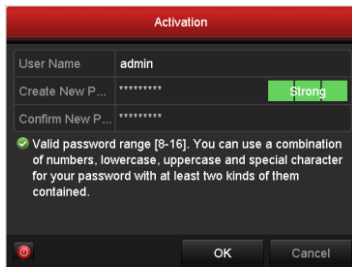

Passo 5. Inicie sessão no DVR. Introduza a palavra-passe de administrador.

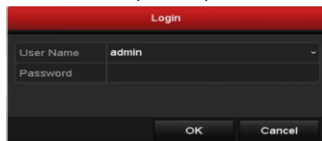

Passo 6. Siga os passos do Assistente de Configuração para configurar as câmaras de rede.

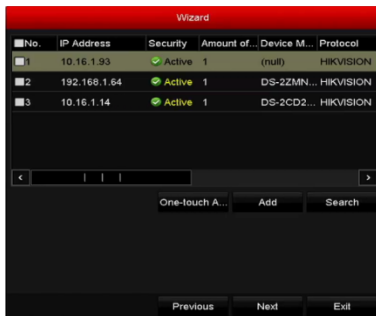

No.	IP Address	Security	Amount of ...	Device M...	Protocol
1	10.16.1.93	Active	1	(null)	HIKVISION
2	192.168.1.64	Active	1	DS-2ZMN...	HIKVISION
3	10.16.1.14	Active	1	DS-2CD2...	HIKVISION

Passo 7. Pode executar a operação e configuração do dispositivo, incluindo a vista em direto, programação de gravação, reprodução, cópia de segurança, etc.



(Opcional) Pode também iniciar sessão no DVR para configurar e controlar através do navegador web. Introduza o endereço IP do dispositivo e prima Enter.



Desfrute do seu Conceptronic DVR!